

# MDE/MDG20PD SUPER-CAPACITY DRYER



## EXTRA-LARGE CAPACITY

- 7.4-cu.-ft. capacity allows for large loads to be dried effectively and efficiently.
- Optimal drying experience maximizes facility productivity.



## INTELLIGENT CONTROLS WITH M-SERIES TECHNOLOGY

- Simple programming and set-up options that allow adjustable cycle prices, cycle times, and vend counts put owners in charge of profits.
- Engineered with intuitive diagnostics for streamlined service.



## FOUR ROLLER SUSPENSION WITH PERMANENTLY LUBRICATED BEARINGS

- Designed to provide consistent and dependable drying, cycle after cycle.



## PORCELAIN-ENAMEL TOP

- Possesses the strength and craftsmanship required for the traffic of a commercial laundry environment.
- Boosts durability and aesthetics.

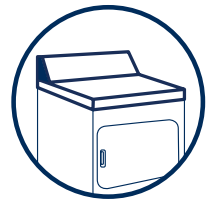

## FULL-WRAP CONSOLE

- Sleek, one-piece full-metal console is robust and easy to clean.
- Protects internal components from unexpected liquids or vapors.

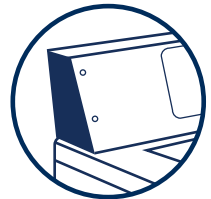

## FRONT ACCESS PANEL

- Easy to remove, streamlining service by providing fast access to internal components.

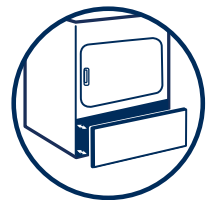

## EXTRA-LARGE REVERSIBLE DOOR

- Provides users unhindered access while loading and unloading clothes.
- Offers convenience and optimal flexibility for a given space.

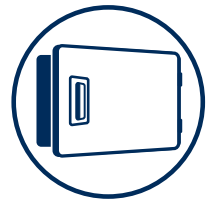

Visit [maytagcommerciallaundry.com](http://maytagcommerciallaundry.com) or call 800-662-3587

MY170015

## OUR COMMITMENT TO DEPENDABLE QUALITY

We understand what dependability means to your owners. That's why we use sturdy components and engineer our products to withstand tough commercial laundry environments for years. Our machines deliver consistent results, powerfully cleaning loads of varying sizes with ease. And because we trust our machines to perform, we back them with exceptional warranties. That's what reliability means to Maytag.

## MAYTAG® COMMERCIAL SUPER-CAPACITY DRYER INTELLIGENT CONTROLS, COIN-DROP

DRYER SPECIFICATIONS	
<b>MODELS</b>	MDE/MDG20PDAYW/DOMESTIC MDE/MDG20PDAZW/CANADA
<b>MOTOR SIZE—HP (KW)</b>	1/3 (.25)
<b>AIRFLOW—CFM MDE/MDG MODEL</b>	178/183
<b>ELECTRIC HEATING ELEMENT (WATTS) DOMESTIC/CANADA</b>	5,600/5,250
<b>GAS RATING—BTU/HR. (KCAL/HR.)</b>	22,000 (5,544)
<b>GAS INLET SIZE</b>	3/8 N.P.T.
<b>CAPACITY</b>	
Cylinder volume—cu. ft. (liters)	7.4 (210)
Cylinder diameter—in. (mm)	26.26 (667)
Cylinder depth—in. (mm)	23.2 (590)
<b>DIMENSIONS</b>	
Width—in. (mm)	27 (686)
Depth—in. (mm)	29.25 (743)
Height—in. (mm)	43 (1,092)
Door opening—in. (mm)	20.25 (514)
Exhaust duct diameter—in. (mm)	4 (101.6)
<b>CRATED DIMENSIONS</b>	
Width—in. (mm)	28.8 (731)
Depth—in. (mm)	30.8 (782)
Height—in. (mm)	44.65 (1,134)
<b>APPROXIMATE WEIGHT</b>	
Uncrated—lbs. (kg) MDE/MDG model	125 (56.7)/130 (59)
Crated—lbs. (kg) MDE/MDG model	135 (51.2)/140 (63.5)
<b>ELECTRICAL REQUIREMENTS</b>	
Electrical rating—voltage/HZ MDE/MDG model	240V/60Hz/120V/60Hz
Breaker/Fuse—amps MDE/MDG model	30/15
<b>WARRANTY</b>	5-Year Limited
Dimensions are for planning purposes only. See specific instructions for proper installation. Because of continuous product improvement, Maytag reserves the right to change specifications without notice.	

# MDE/MDG20PD SUPER-CAPACITY DRYER

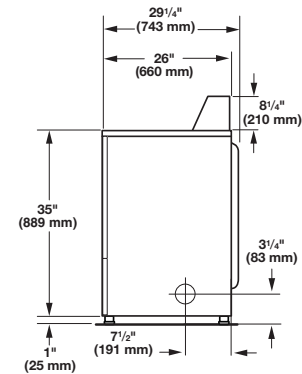

Side View

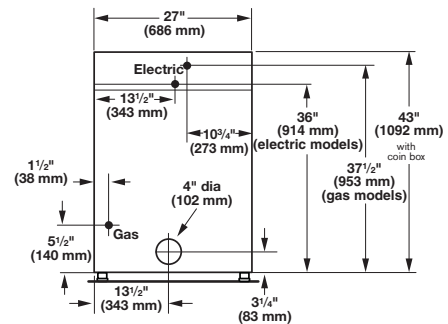

Back View



### 5-YEAR LIMITED WARRANTY ALL PARTS COVERED

See [maytagcommerciallaundry.com](http://maytagcommerciallaundry.com) for complete warranty details.

### MAXIMUM EXHAUST DUCT LENGTH PER NUMBER OF TURNS

Number Of  
90° Turns

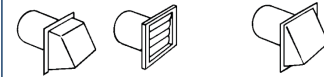

#### Rigid Metal Vent

	Box Hood and Louvered Style	Angled Hood Style
0	64 ft. (19.5 m)	58 ft. (17.7 m)
1	54 ft. (16.5 m)	48 ft. (14.6 m)
2	44 ft. (13.4 m)	38 ft. (11.6 m)
3	35 ft. (10.7 m)	29 ft. (8.8 m)
4	27 ft. (8.2 m)	21 ft. (6.4 m)